

IFV BORSUK

POLISH ARMORED FIST



72808



IFV BORSUK

POLISH ARMORED FIST

1/72 Full 3D Print Military Miniatures Series

Model no.: 72A08

Box contains one complete unassembled model kit.

Glue and paint are not included.

Not Recommended for children under 13.

Thank you for choosing our product.

Our models are made in 3D printing technology from photopolymer resins.

72A08



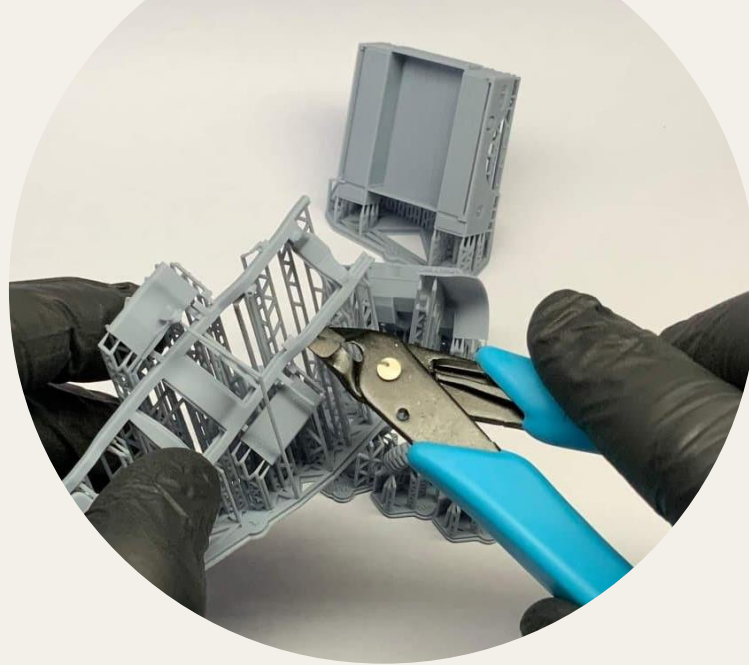
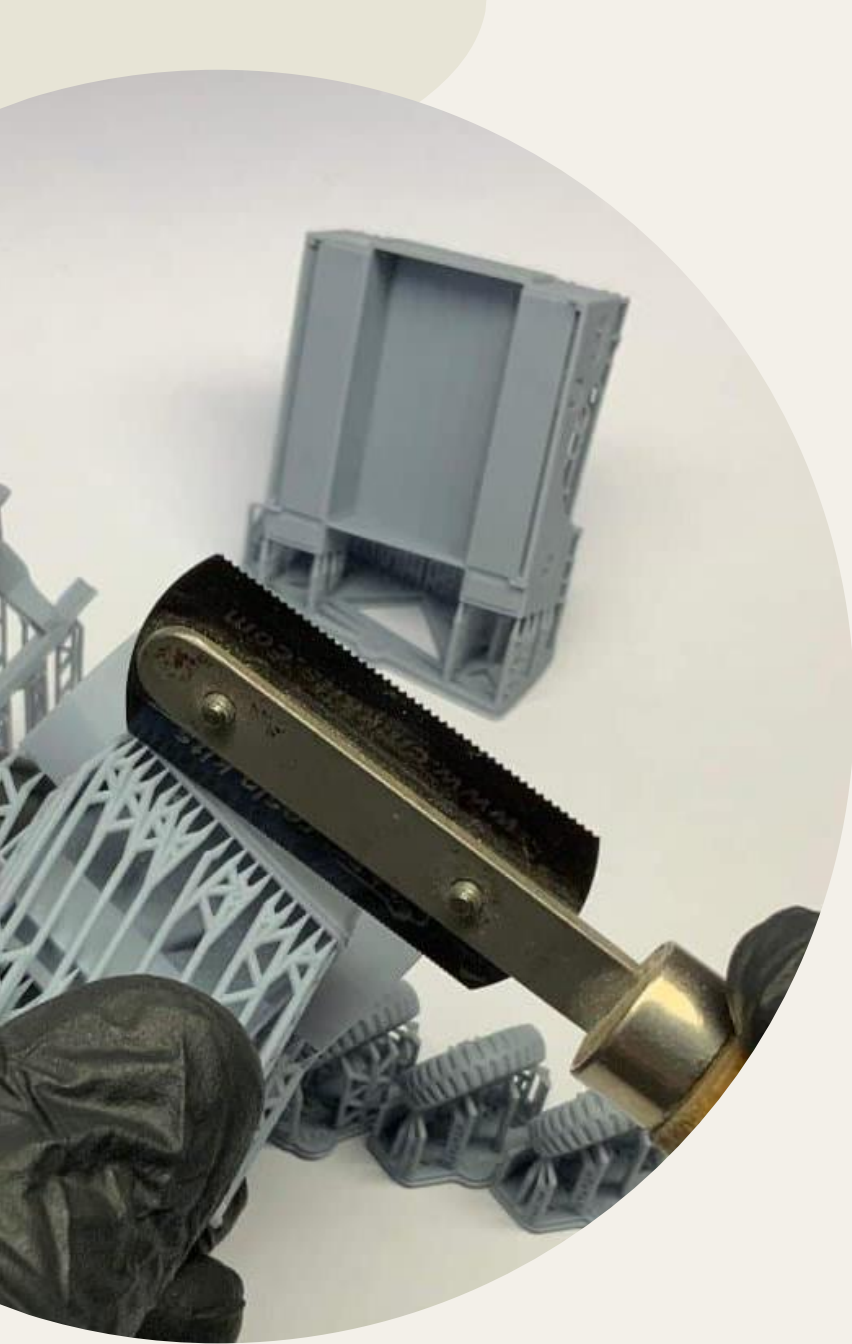

A few tips and tricks how to prepare our models

- 1 - *Cutting off printing supports ...*
 - *modelling knife*
 - *modelling cutter*
 - *modelling saw*

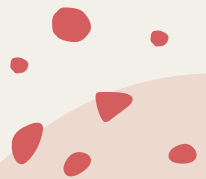

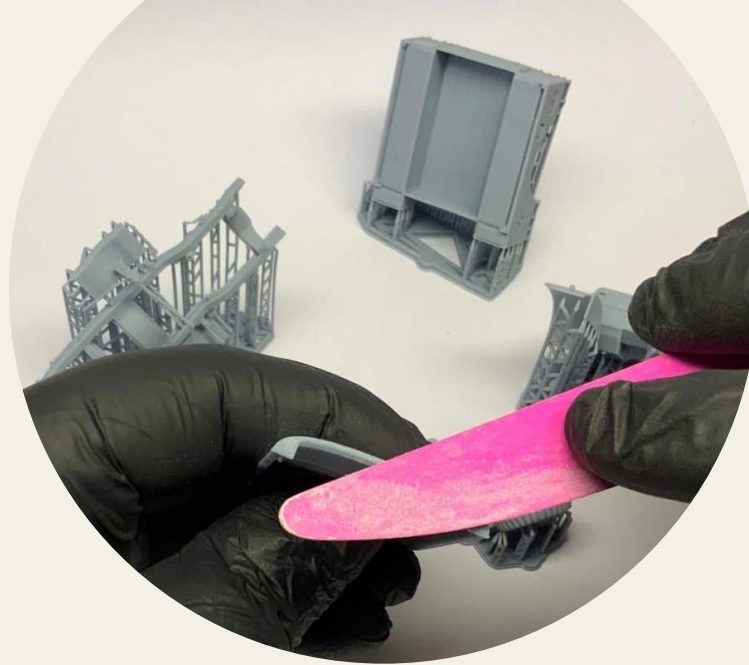

- 2 - Grinding and sanding ...*
- modelling grinding wool*
 - modelling sponge*
 - modelling file*



THE BUILT ...

1

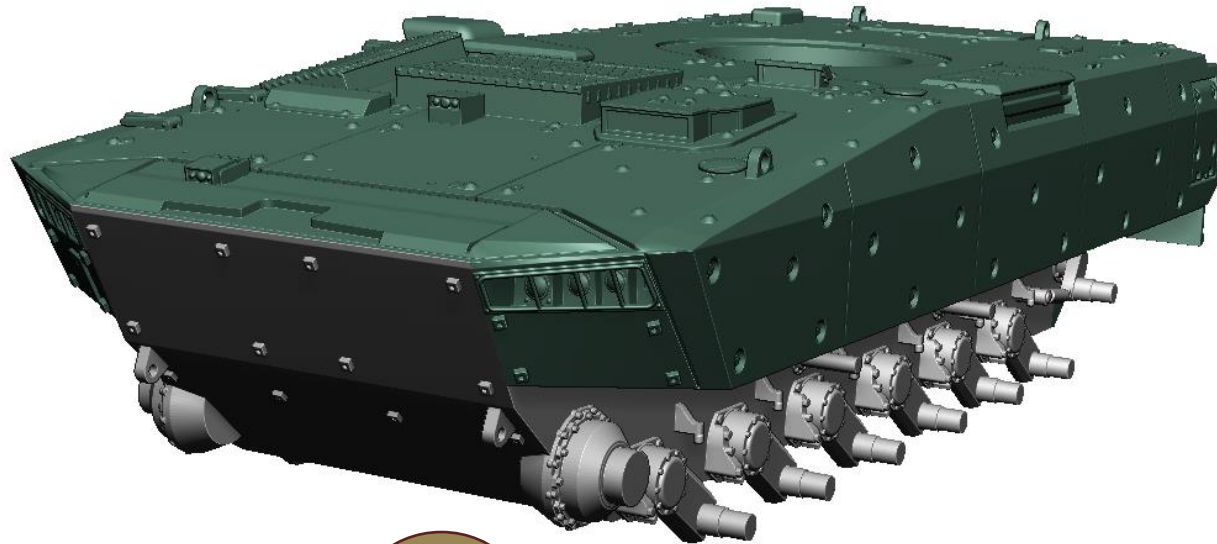

BODY

2



72Λ08

TRACKS & FENDERS



DOG FIGHT
WORKSHOP

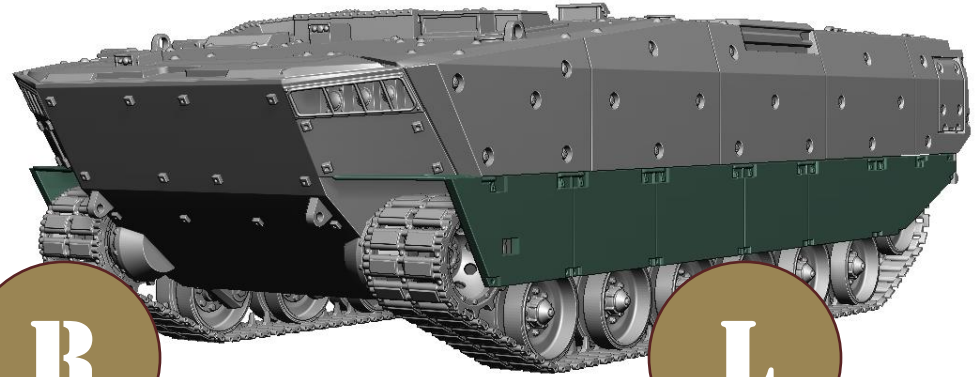

R

L

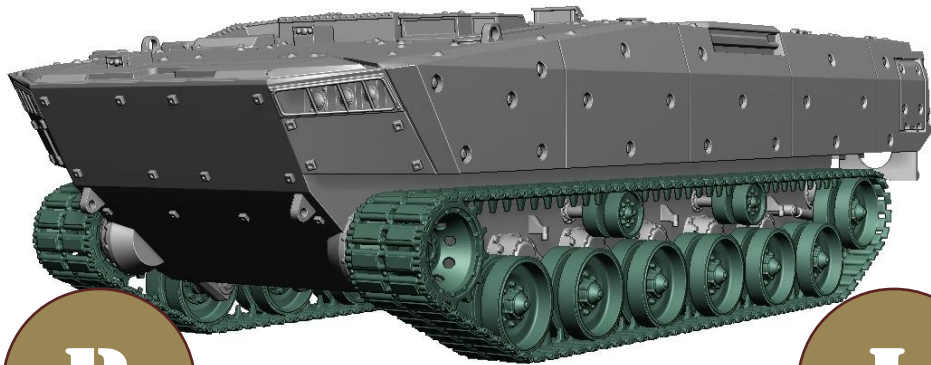

R

L

72Λ08

**FRONT ARMOR
OPTION**

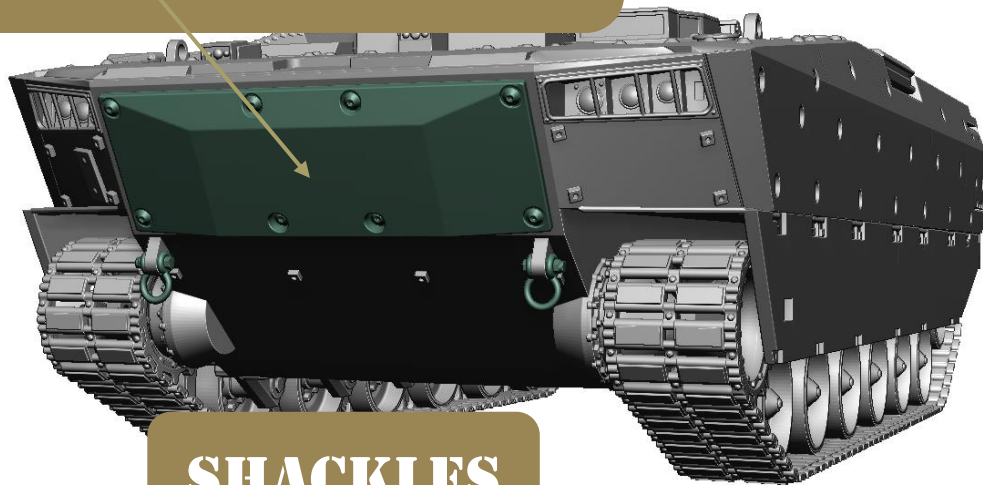

SHACKLES



**DOGFIGHT
WORKSHOP**

DETAILS

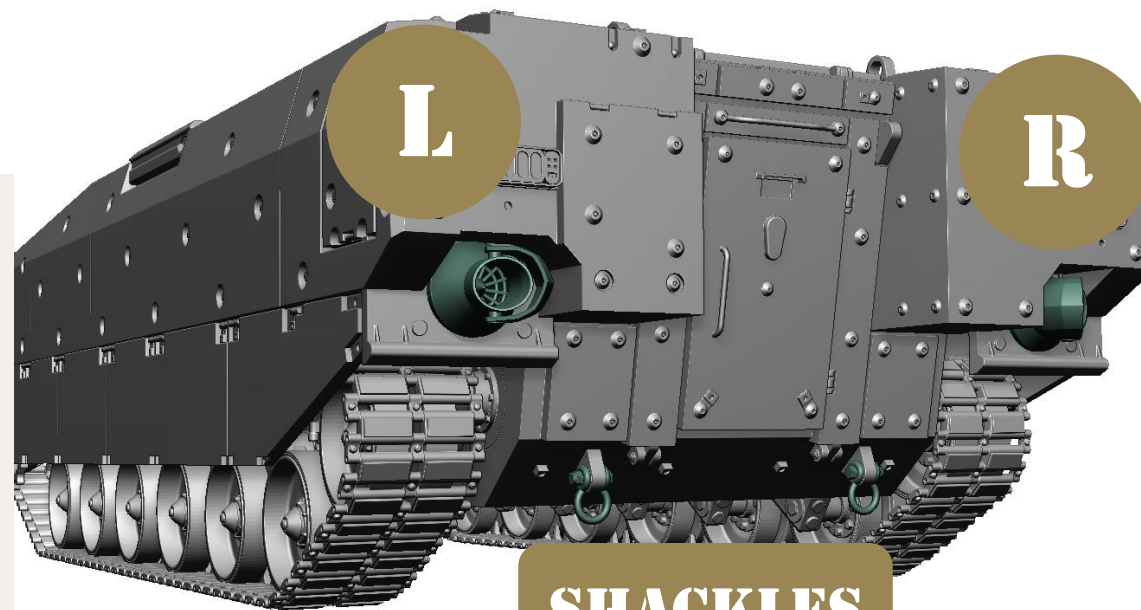

SHACKLES

72A08

DETAILS

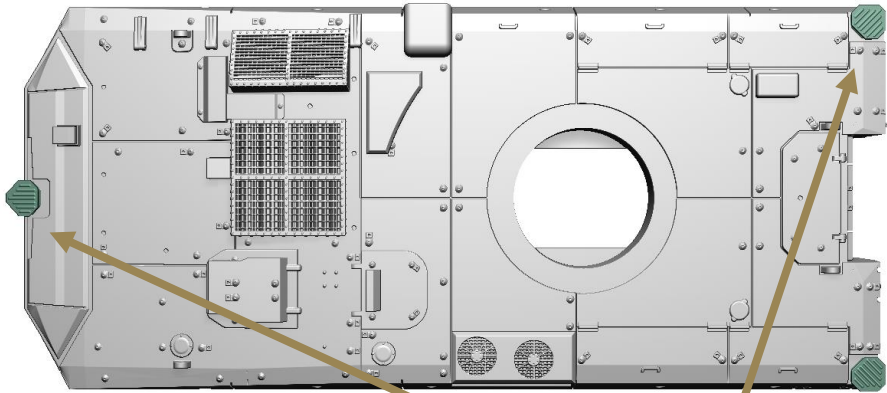

X3

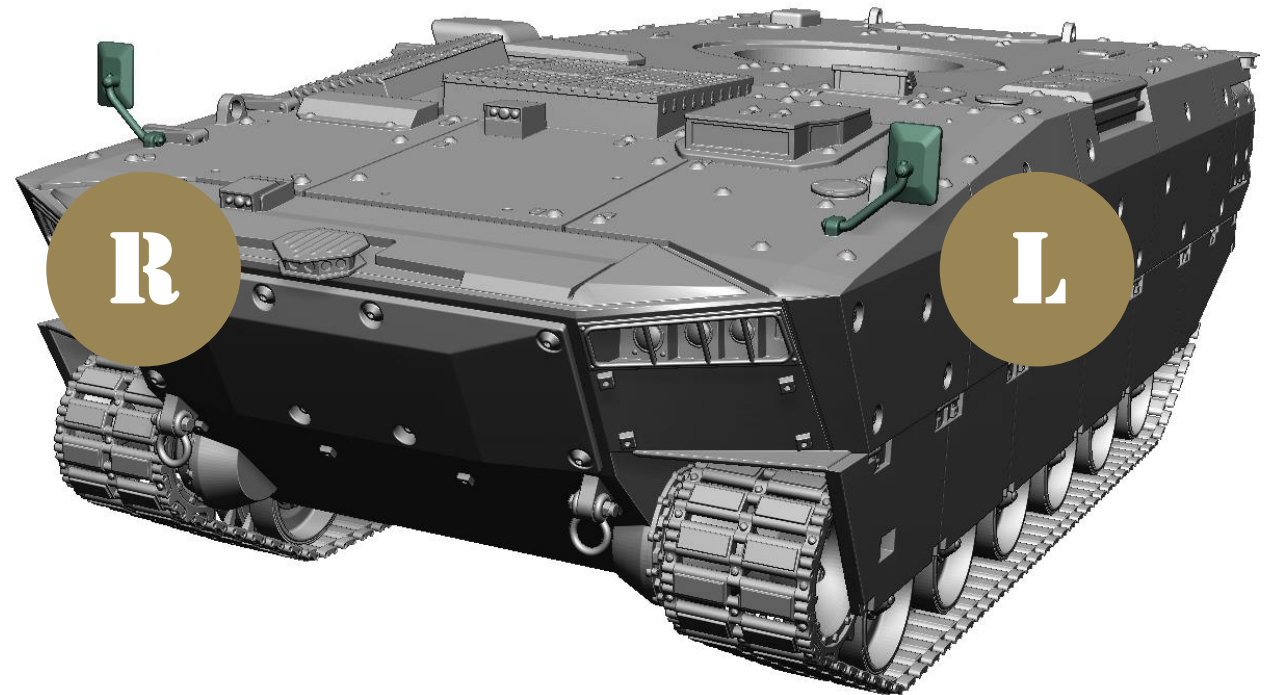

72A08

ZSSW-30

BUSHMASTER Mk. 44s

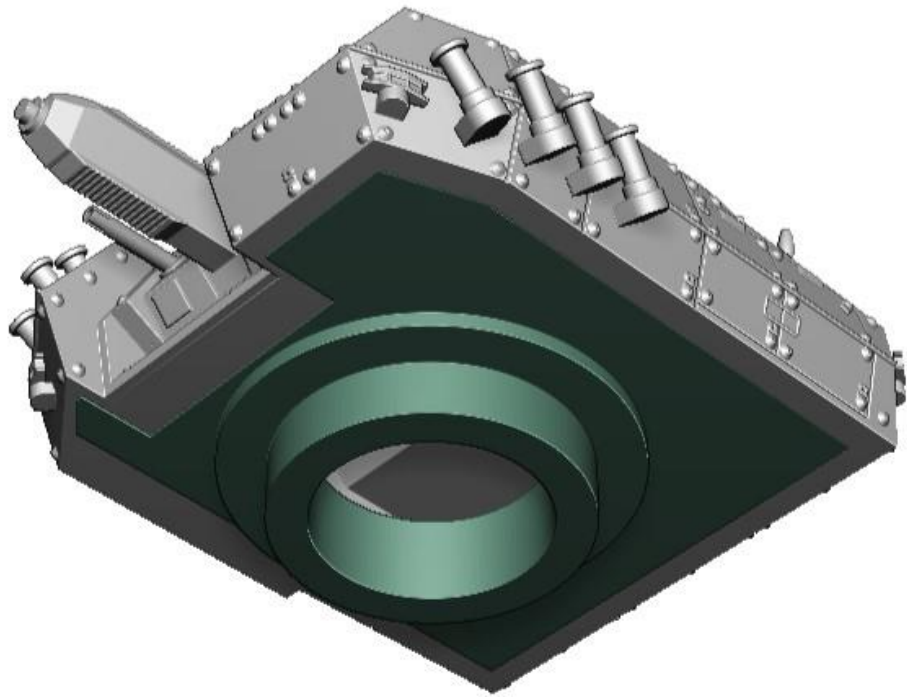

BASE TURRET

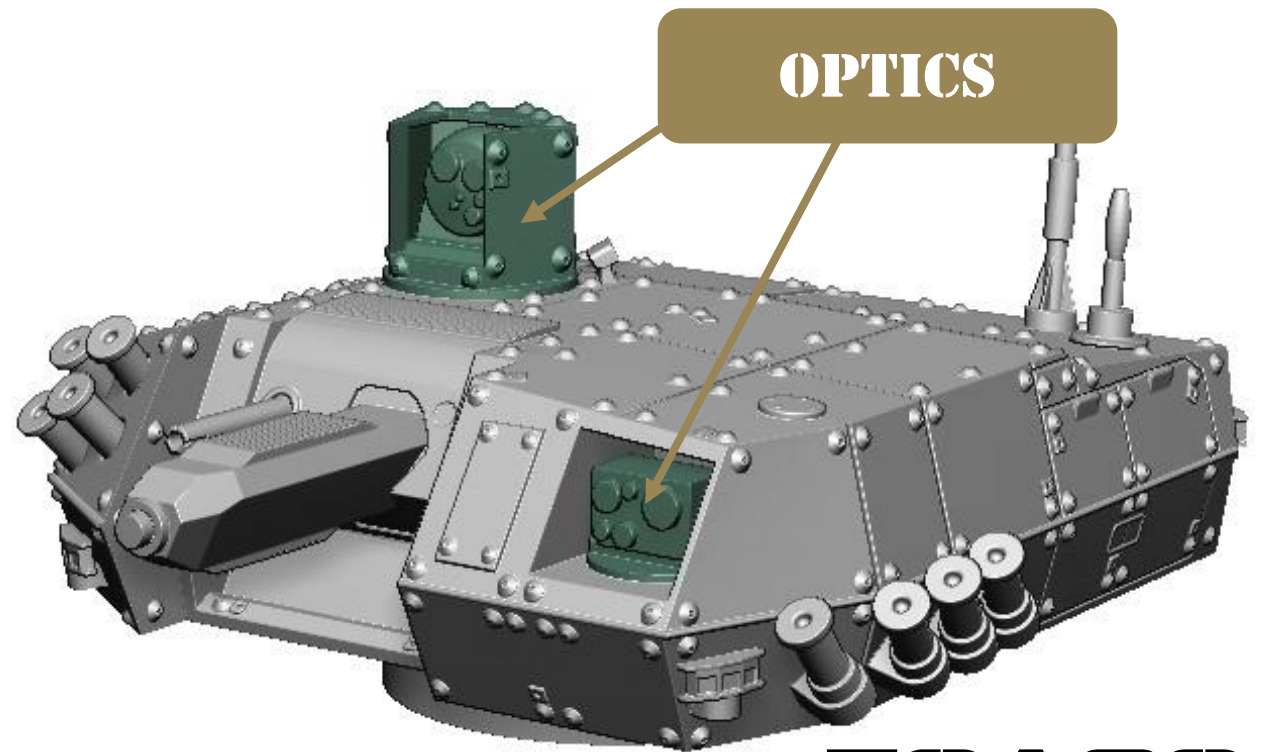

72A08

ZSSW-30

BUSHMASTER Mk. 44s

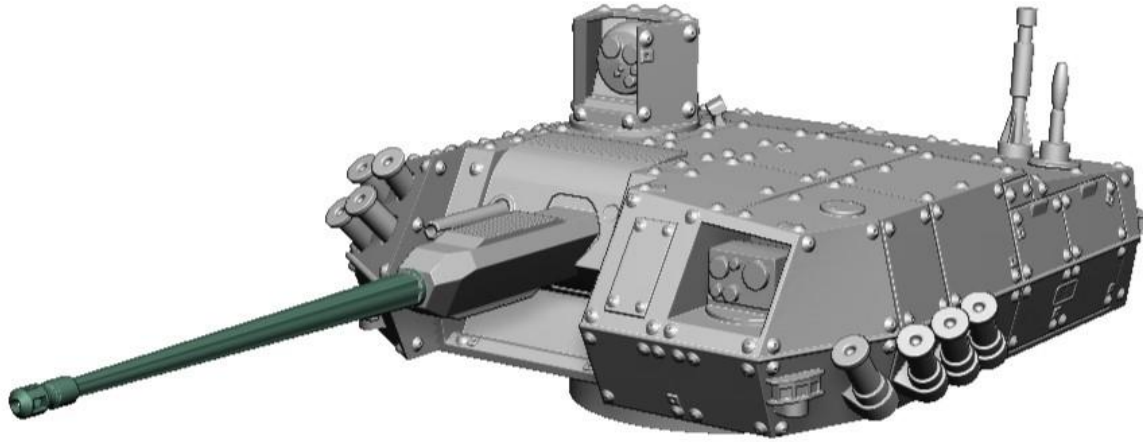

BUSHMASTER GUN

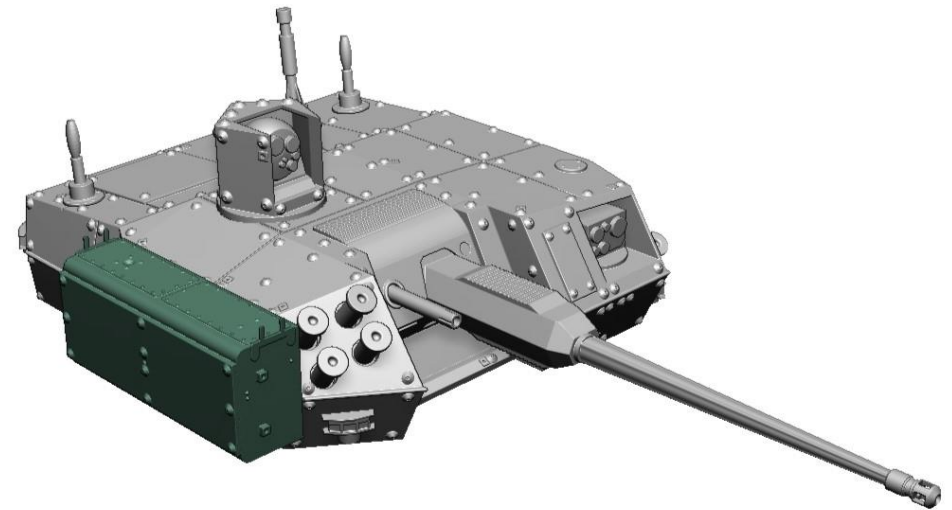

RTCS-30 SPIKE



DOGFIGHT
WORKSHOP

72Λ08

IFV BORSUK

72A08

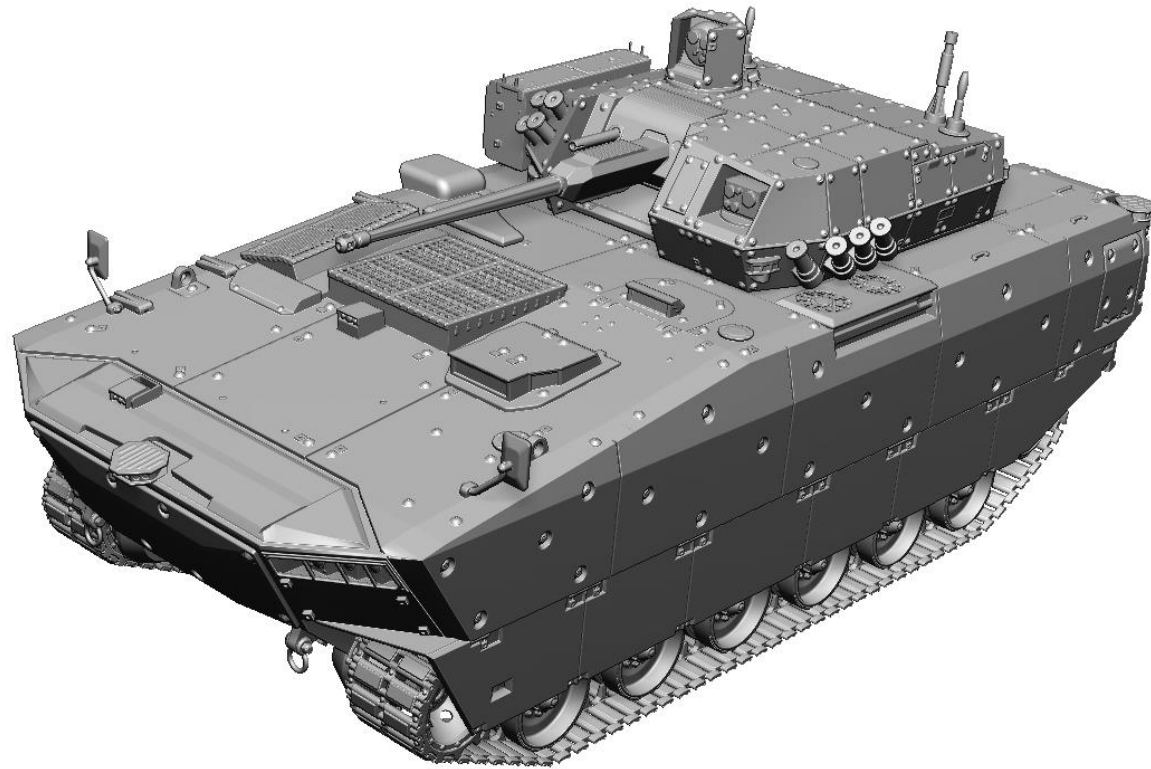

DOGFIGHT
WORKSHOP

IFV BORSUK

72A08

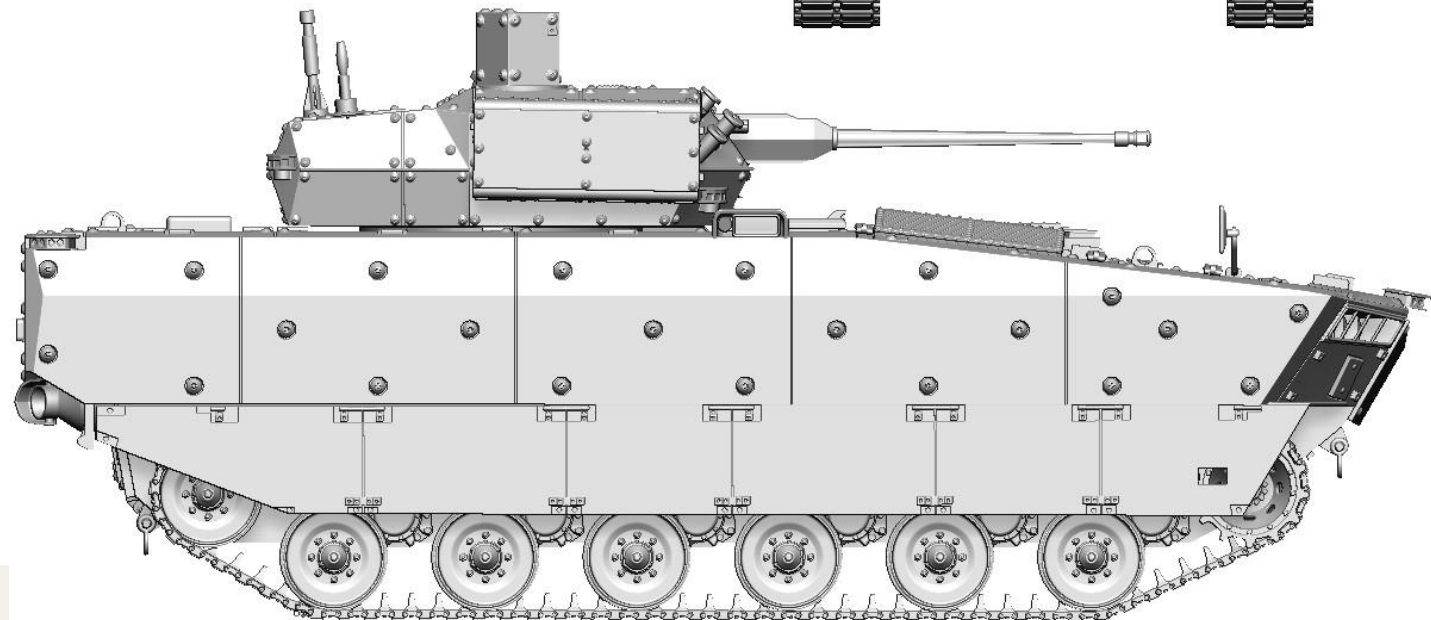
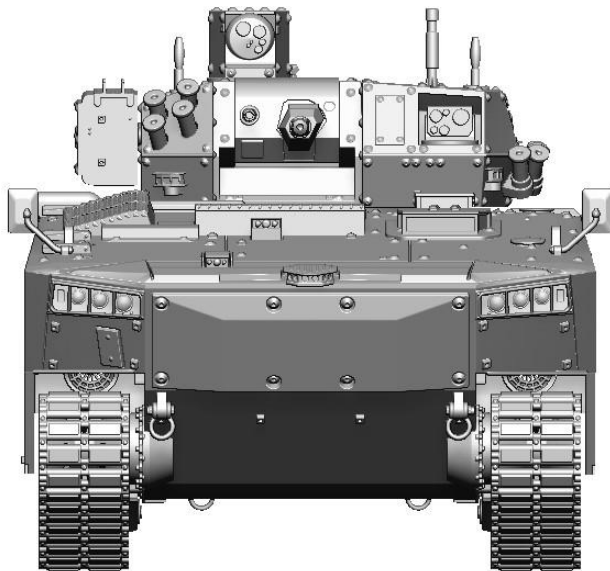
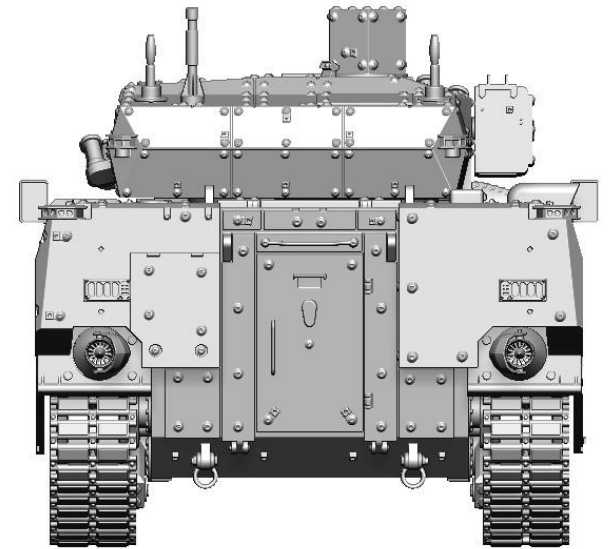
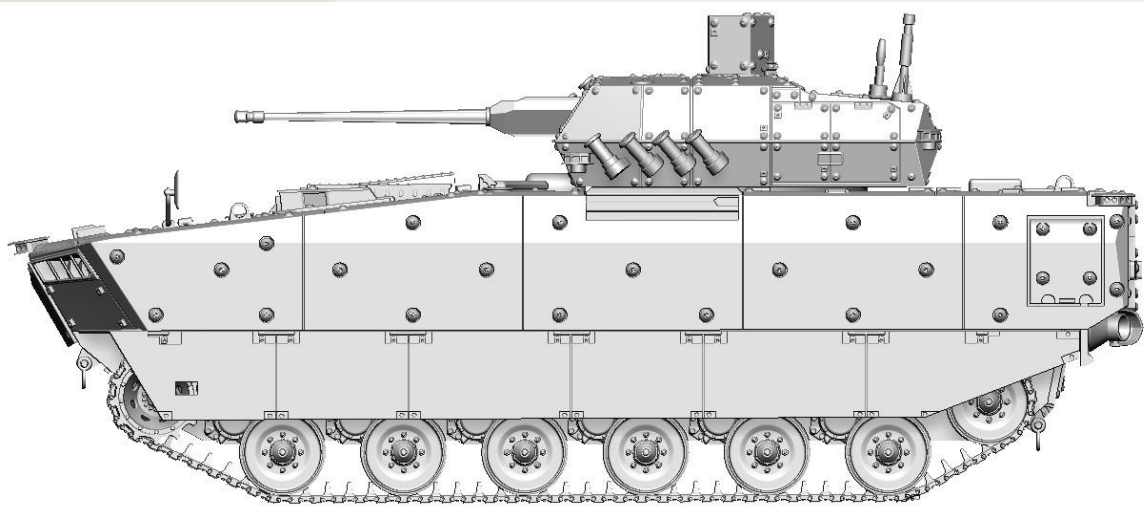

DOGFIGHT
WORKSHOP



DOGFIGHT
WORKSHOP

Thank you for choosing our product. With each subsequent one we make every effort to make our models better and better.

Happy Modelling

Dogfight Workshop Team

www.dogfightworkshop.pl

office@dogfightworkshop.pl